



TABLE 1. PIN DESCRIPTIONS

Number	Name	Type		Description
2, 5, 11, 26, 32, 35, 41, 44	V _{DDO}	Power		Output supply pins.
7, 9, 18, 28, 30, 37, 39, 46, 48	GND	Power		Output power supply.
16, 20	V _{DD}	Power		Positive supply pins.
25, 27, 29, 31, 33	QA0, QA1, QA2, QA3, QA4	Output		Bank A outputs. 7Ω typical output impedance. LVCMOS/LVTTL interface levels.
34, 36, 38, 40, 42	QB0, QB1, QB2, QB3, QB4	Output		Bank B outputs. 7Ω typical output impedance. LVCMOS/LVTTL interface levels.
43, 45, 47, 1, 3	QC0, QC1, QC2, QC3, QC4	Output		Bank C outputs. 7Ω typical output impedance. LVCMOS/LVTTL interface levels.
4, 6, 8, 10, 12	QD0, QD1, QD2, QD3, QD4	Output		Bank D outputs. 7Ω typical output impedance. LVCMOS/LVTTL interface levels.
22	CLK	Input	Pulldown	Non-inverting differential clock input.
21	nCLK	Input	Pullup	Inverting differential clock input.
13	DIV_SELD	Input	Pullup	Controls frequency division for Bank D outputs. LVCMOS/LVTTL interface levels.
14	DIV_SELC	Input	Pullup	Controls frequency division for Bank C outputs. LVCMOS/LVTTL interface levels.
23	DIV_SELB	Input	Pullup	Controls frequency division for Bank B outputs. LVCMOS/LVTTL interface levels.
24	DIV SELA	Input	Pullup	Controls frequency division for Bank A outputs. LVCMOS/LVTTL interface levels.
17, 19	BANK_EN1, BANK_EN0	Input	Pullup	Enables and disables outputs by banks. LVCMOS/LVTTL interface levels.
15	nMR/OE	Input	Pullup	Master Reset and output enable. When HIGH, output drivers are enabled. When LOW, output drivers are in HiZ and dividers are reset. LVCMOS/LVTTL interface levels.

NOTE: Pullup and Pulldown refer to internal input resistors. See Table 2, Pin Characteristics, for typical values.

TABLE 2. PIN CHARACTERISTICS

Symbol	Parameter	Test Conditions	Minimum	Typical	Maximum	Units
C _{IN}	Input Capacitance			4		pF
R _{PULLUP}	Input Pullup Resistor			51		kΩ
R _{PULLDOWN}	Input Pulldown Resistor			51		kΩ
C _{PD}	Power Dissipation Capacitance (per output)	V _{DD} = V _{DDO} = 3.465V			15	pF
R _{OUT}	Output Impedance			7		Ω



TABLE 3A. CONTROL INPUT FUNCTION TABLE

Inputs				Outputs				
nMR/OE	BANK_EN1	BANK_EN0	DIV_SELx	QA0:QA4	QB0:QB4	QC0:QC4	QD0:QD4	Qx Frequency
0	X	X	X	Hi Z	Hi Z	Hi Z	Hi Z	zero
1	0	0	0	Enabled	Hi Z	Hi Z	Hi Z	fIN/2
1	1	0	0	Enabled	Enabled	Hi Z	Hi Z	fIN/2
1	0	1	0	Enabled	Enabled	Enabled	Hi Z	fIN/2
1	1	1	0	Enabled	Enabled	Enabled	Enabled	fIN/2
1	0	0	1	Enabled	Hi Z	Hi Z	Hi Z	fIN
1	1	0	1	Enabled	Enabled	Hi Z	Hi Z	fIN
1	0	1	1	Enabled	Enabled	Enabled	Hi Z	fIN
1	1	1	1	Enabled	Enabled	Enabled	Enabled	fIN

TABLE 3B. CLOCK INPUT FUNCTION TABLE

Inputs			Outputs	Input to Output Mode	Polarity
nMR/OE	CLK	nCLK	Qx0:Qx4		
1	0	1	LOW	Differential to Single Ended	Non Inverting
1	1	0	HIGH	Differential to Single Ended	Non Inverting
1	0	Biased; NOTE 1	LOW	Single Ended to Single Ended	Non Inverting
1	1	Biased; NOTE 1	HIGH	Single Ended to Single Ended	Non Inverting
1	Biased; NOTE 1	0	HIGH	Single Ended to Single Ended	Inverting
1	Biased; NOTE 1	1	LOW	Single Ended to Single Ended	Inverting

NOTE 1: Please refer to the Application Information section, which discusses "Wiring the Differential Input to Accept Single Ended Levels".



ABSOLUTE MAXIMUM RATINGS

Supply Voltage, V_{DD}	4.6V
Inputs, V_I	-0.5V to $V_{DD} + 0.5V$
Outputs, V_O	-0.5V to $V_{DDO} + 0.5V$
Package Thermal Impedance, θ_{JA}	47.9°C/W (0 lfpm)
Storage Temperature, T_{STG}	-65°C to 150°C

NOTE: Stresses beyond those listed under Absolute Maximum Ratings may cause permanent damage to the device. These ratings are stress specifications only. Functional operation of product at these conditions or any conditions beyond those listed in the *DC Characteristics* or *AC Characteristics* is not implied. Exposure to absolute maximum rating conditions for extended periods may affect product reliability.

TABLE 4A. POWER SUPPLY DC CHARACTERISTICS, $V_{DD} = V_{DDO} = 3.3V \pm 5\%$, $T_A = 0^\circ C$ TO $70^\circ C$

Symbol	Parameter	Test Conditions	Minimum	Typical	Maximum	Units
V_{DD}	Positive Supply Voltage		3.135	3.3	3.465	V
V_{DDO}	Output Supply Voltage		3.135	3.3	3.465	V
I_{DD}	Power Supply Current				95	mA

TABLE 4B. POWER SUPPLY DC CHARACTERISTICS, $V_{DD} = 3.3V \pm 5\%$, $V_{DDO} = 2.5V \pm 5\%$, $T_A = 0^\circ C$ TO $70^\circ C$

Symbol	Parameter	Test Conditions	Minimum	Typical	Maximum	Units
V_{DD}	Positive Supply Voltage		3.135	3.3	3.465	V
V_{DDO}	Output Supply Voltage		2.375	2.5	2.625	V
I_{DD}	Power Supply Current				95	mA

TABLE 4C. LVCMOS /LVTTL DC CHARACTERISTICS, $V_{DD} = V_{DDO} = 3.3V \pm 5\%$, $T_A = 0^\circ C$ TO $70^\circ C$

Symbol	Parameter	Test Conditions	Minimum	Typical	Maximum	Units
V_{IH}	Input High Voltage	DIV_SELA, DIV_SELB, DIV_SELC, DIV_SELD, BANK_EN0, BANK_EN1, nMR/OE	2		$V_{DD} + 0.3$	V
V_{IL}	Input Low Voltage	DIV_SELA, DIV_SELB, DIV_SELC, DIV_SELD, BANK_EN0, BANK_EN1, nMR/OE	-0.3		0.8	V
I_{IH}	Input High Current	DIV_SELA, DIV_SELB, DIV_SELC, DIV_SELD, BANK_EN0, BANK_EN1, nMR/OE	$V_{DD} = V_{IN} = 3.465V$		5	μA
I_{IL}	Input Low Current	DIV_SELA, DIV_SELB, DIV_SELC, DIV_SELD, BANK_EN0, BANK_EN1, nMR/OE	$V_{DD} = 3.465V, V_{IN} = 0V$		-150	μA
V_{OH}	Output High Voltage	$V_{DD} = V_{DDO} = 3.135V$ $I_{OH} = -36mA$	2.6			V
V_{OL}	Output Low Voltage	$V_{DD} = V_{DDO} = 3.135V$ $I_{OL} = 36mA$			0.5	V



TABLE 4D. LVCMOS/LVTTL DC CHARACTERISTICS, $V_{DD} = 3.3V \pm 5\%$, $V_{DDO} = 2.5V \pm 5\%$, $T_A = 0^\circ C$ TO $70^\circ C$

Symbol	Parameter	Test Conditions	Minimum	Typical	Maximum	Units
V_{IH}	Input High Voltage	DIV_SELA, DIV_SELB, DIV_SEL C, DIV_SELD, BANK_EN0, BANK_EN1, nMR/OE	2		$V_{DD} + 0.3$	V
V_{IL}	Input Low Voltage	DIV_SELA, DIV_SELB, DIV_SEL C, DIV_SELD, BANK_EN0, BANK_EN1, nMR/OE	-0.3		0.8	V
I_{IH}	Input High Current	DIV_SELA, DIV_SELB, DIV_SEL C, DIV_SELD, BANK_EN0, BANK_EN1, nMR/OE	$V_{DD} = V_{IN} = 3.465V$		5	μA
I_{IL}	Input Low Current	DIV_SELA, DIV_SELB, DIV_SEL C, DIV_SELD, BANK_EN0, BANK_EN1, nMR/OE	$V_{DD} = 3.465V, V_{IN} = 0V$	-150		μA
V_{OH}	Output High Voltage		$V_{DD} = 3.135V$ $V_{DDO} = 2.375V$ $I_{OL} = -27mA$	1.9		V
V_{OL}	Output Low Voltage		$V_{DD} = 3.135V$ $V_{DDO} = 2.375V$ $I_{OL} = 27mA$		0.5	V

TABLE 4E. DIFFERENTIAL DC CHARACTERISTICS, $V_{DD} = 3.3V \pm 5\%$, $V_{DDO} = 3.3V \pm 5\%$ OR $2.5V \pm 5\%$, $T_A = 0^\circ C$ TO $70^\circ C$

Symbol	Parameter	Test Conditions	Minimum	Typical	Maximum	Units
I_{IH}	Input High Current	CLK	$V_{DD} = V_{IN} = 3.465V$		150	μA
		nCLK	$V_{DD} = V_{IN} = 3.465V$		5	μA
I_{IL}	Input Low Current	CLK	$V_{DD} = 3.465V, V_{IN} = 0V$	-5		μA
		nCLK	$V_{DD} = 3.465V, V_{IN} = 0V$	-150		μA
V_{PP}	Peak-to-Peak Input Voltage		0.15		1.3	V
V_{CMR}	Common Mode Input Voltage; NOTE 1, 2		1.8		2.4	V
		DCM, LVHSTL, LVDS, SSTL Levels	0.31		1.3	V

NOTE 1: Common mode voltage is defined as V_{IH} .

NOTE 2: For single ended applications, the maximum input voltage for CLK and nCLK is $V_{DD} + 0.3V$.



TABLE 5A. AC CHARACTERISTICS, $V_{DD} = V_{DDO} = 3.3V \pm 5\%$, $T_A = 0^\circ C$ TO $70^\circ C$

Symbol	Parameter	Test Conditions	Minimum	Typical	Maximum	Units
f_{MAX}	Output Frequency				250	MHz
t_{PD}	Propagation Delay; NOTE 1	$f \leq 200MHz$	2.2		3.5	ns
$t_{sk}(b)$	Bank Skew; NOTE 2, 7	Measured on rising edge at $V_{DDO}/2$			150	ps
$t_{sk}(o)$	Output Skew; NOTE 3, 7	Measured on rising edge at $V_{DDO}/2$			200	ps
$t_{sk}(w)$	Multiple Frequency Skew; NOTE 4, 7	Measured on rising edge at $V_{DDO}/2$			250	ps
$t_{sk}(pp)$	Part-to-Part Skew; NOTE 5, 7	Measured on rising edge at $V_{DDO}/2$			650	ps
t_R	Output Rise Time; NOTE 6	30% to 70%	280		850	ps
t_F	Output Fall Time; NOTE 6	30% to 70%	280		850	ps
odc	Output Duty Cycle	$f \leq 200MHz$	$t_{CYCLE}/2 - 0.5$	$t_{CYCLE}/2$	$t_{CYCLE}/2 + 0.5$	ns
		$f = 200MHz$	2	2.5	3	ns
t_{EN}	Output Enable Time; NOTE 6	$f = 10MHz$			6	ns
t_{DIS}	Output Disable Time; NOTE 6	$f = 10MHz$			6	ns

All parameters measured at 200MHz unless noted otherwise.

NOTE 1: Measured from the differential input crossing point to the output at $V_{DDO}/2$.

NOTE 2: Defined as skew within a bank of outputs at the same supply voltages and with equal load conditions.

NOTE 3: Defined as skew between outputs at the same supply voltage and with equal load conditions.

Measured at $V_{DDO}/2$.

NOTE 4: Defined as skew across banks of outputs operating at different frequency with the same supply voltages and equal load conditions.

NOTE 5: Defined as the skew between outputs on different devices operating at the same supply voltages and with equal load conditions. Using the same type of inputs on each device, the outputs are measured at $V_{DDO}/2$.

NOTE 6: These parameters are guaranteed by characterization. Not tested in production.

NOTE 7: This parameter is defined in accordance with JEDEC Standard 65.



TABLE 5B. AC CHARACTERISTICS, $V_{DD} = 3.3V \pm 5\%$, $V_{DDO} = 2.5V \pm 5\%$, $T_A = 0^\circ C$ TO $70^\circ C$

Symbol	Parameter	Test Conditions	Minimum	Typical	Maximum	Units
f_{MAX}	Output Frequency				250	MHz
t_{PD}	Propagation Delay; NOTE 1	$f \leq 200MHz$	2.3		3.6	ns
$tsk(b)$	Bank Skew; NOTE 2, 7	Measured on rising edge at $V_{DDO}/2$			150	ps
$tsk(o)$	Output Skew; NOTE 3, 7	Measured on rising edge at $V_{DDO}/2$			200	ps
$tsk(w)$	Multiple Frequency Skew; NOTE 4, 7	Measured on rising edge at $V_{DDO}/2$			250	ps
$tsk(pp)$	Part-to-Part Skew; NOTE 5, 7	Measured on rising edge at $V_{DDO}/2$			700	ps
t_R	Output Rise Time; NOTE 6	30% to 70%	280		850	ps
t_F	Output Fall Time; NOTE 6	30% to 70%	280		850	ps
odc	Output Duty Cycle	$f \leq 200MHz$	$t_{CYCLE}/2 - 0.5$	$t_{CYCLE}/2$	$t_{CYCLE}/2 + 0.5$	ns
		$f = 200MHz$	2	2.5	3	ns
t_{EN}	Output Enable Time; NOTE 6	$f = 10MHz$			6	ns
t_{DIS}	Output Disable Time; NOTE 6	$f = 10MHz$			6	ns

All parameters measured at 200MHz unless noted otherwise.

NOTE 1: Measured from the differential input crossing point to the output at $V_{DDO}/2$.

NOTE 2: Defined as skew within a bank of outputs at the same supply voltages and with equal load conditions.

NOTE 3: Defined as skew between outputs at the same supply voltage and with equal load conditions.

Measured at $V_{DDO}/2$.

NOTE 4: Defined as skew across banks of outputs operating at different frequency with the same supply voltages and equal load conditions.

NOTE 5: Defined as the skew between outputs on different devices operating at the same supply voltages and with equal load conditions. Using the same type of inputs on each device, the outputs are measured at $V_{DDO}/2$.

NOTE 6: These parameters are guaranteed by characterization. Not tested in production.

NOTE 7: This parameter is defined in accordance with JEDEC Standard 65.



PARAMETER MEASUREMENT INFORMATION

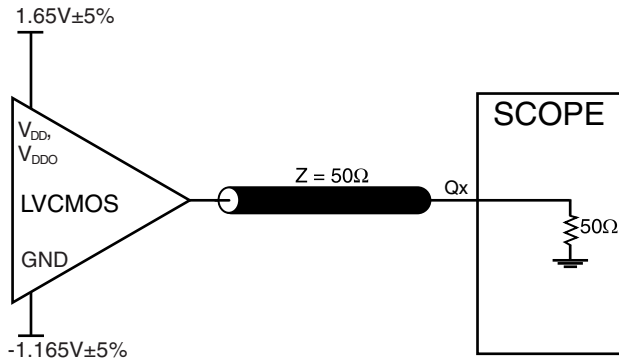

3.3V CORE/3.3V OUTPUT LOAD AC TEST CIRCUIT

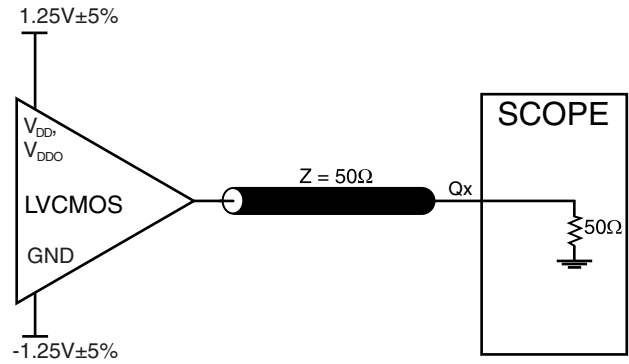

3.3V CORE/2.5V OUTPUT LOAD AC TEST CIRCUIT

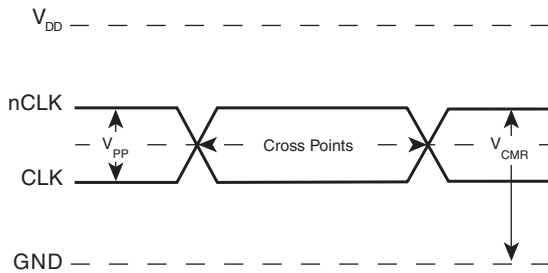

DIFFERENTIAL INPUT LEVEL

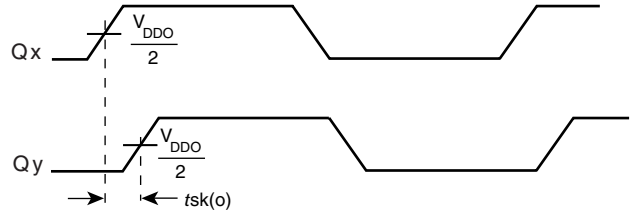

OUTPUT SKEW

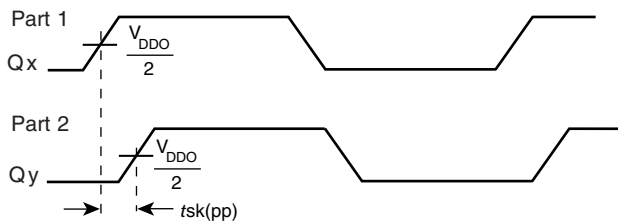

PART-TO-PART SKEW

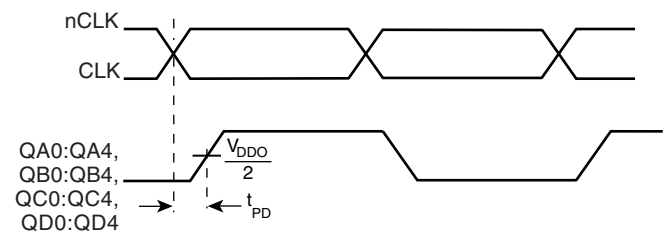

PROPAGATION DELAY

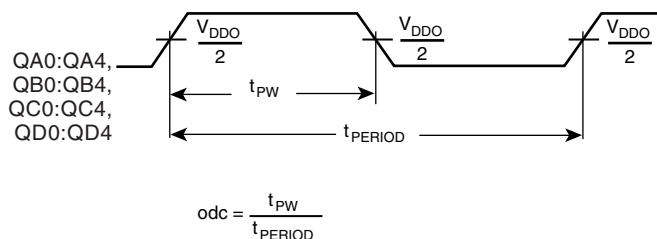

OUTPUT DUTY CYCLE/PULSE WIDTH/PERIOD

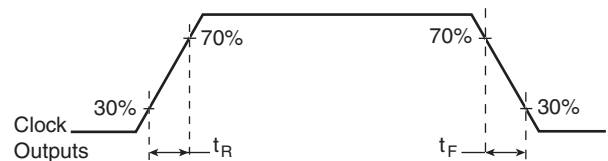

OUTPUT RISE/FALL TIME



APPLICATION INFORMATION

WIRING THE DIFFERENTIAL INPUT TO ACCEPT SINGLE ENDED LEVELS

Figure 1 shows how the differential input can be wired to accept single ended levels. The reference voltage $V_{REF} = V_{DD}/2$ is generated by the bias resistors R1, R2 and C1. This bias circuit should be located as close as possible to the input pin. The

ratio of R1 and R2 might need to be adjusted to position the V_{REF} in the center of the input voltage swing. For example, if the input clock swing is only 2.5V and $V_{DD} = 3.3V$, V_{REF} should be 1.25V and $R2/R1 = 0.609$.

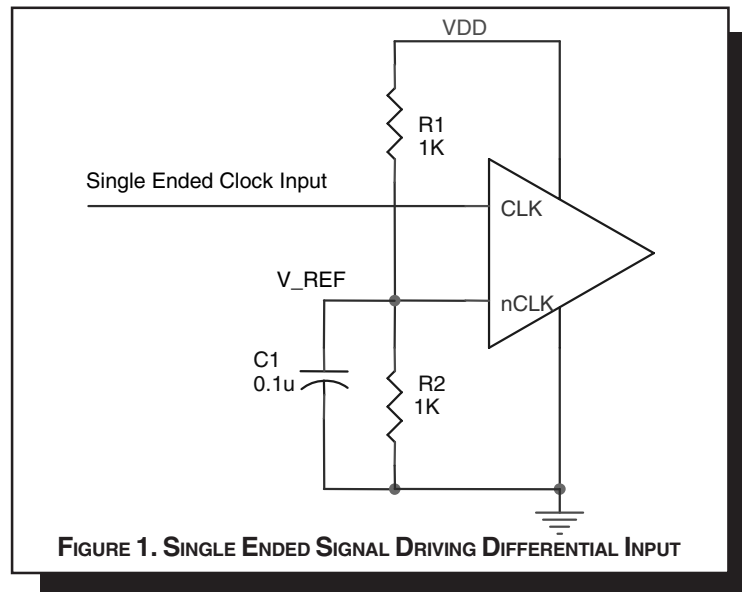

RECOMMENDATIONS FOR UNUSED INPUT AND OUTPUT PINS

INPUTS:

CLK/nCLK INPUT:

For applications not requiring the use of the differential input, both CLK and nCLK can be left floating. Though not required, but for additional protection, a 1kΩ resistor can be tied from CLK to ground.

LVCMOS CONTROL PINS:

All control pins have internal pull-ups or pull-downs; additional resistance is not required but can be added for additional protection. A 1kΩ resistor can be used.

OUTPUTS:

LVCMOS OUTPUT:

All unused LVCMOS output can be left floating. We recommend that there is no trace attached.



POWER CONSIDERATIONS

For Power Dissipation, please refer to a separate Application Note: *Power Dissipation for LVCMOS Buffer.*

DRIVER TERMINATION

For LVCMOS Output Termination, please refer to a separate Application Note: *LVCMOS Driver Termination.*

RELIABILITY INFORMATION

TABLE 7. θ_{JA} vs. AIR FLOW TABLE FOR 48 LQFP

θ_{JA} by Velocity (Linear Feet per Minute)			
	0	200	500
Single-Layer PCB, JEDEC Standard Test Boards	67.8°C/W	55.9°C/W	50.1°C/W
Multi-Layer PCB, JEDEC Standard Test Boards	47.9°C/W	42.1°C/W	39.4°C/W

NOTE: Most modern PCB designs use multi-layered boards. The data in the second row pertains to most designs.

TRANSISTOR COUNT

The transistor count for ICS8702 is: 1746



PACKAGE OUTLINE - Y SUFFIX FOR 48 LQFP

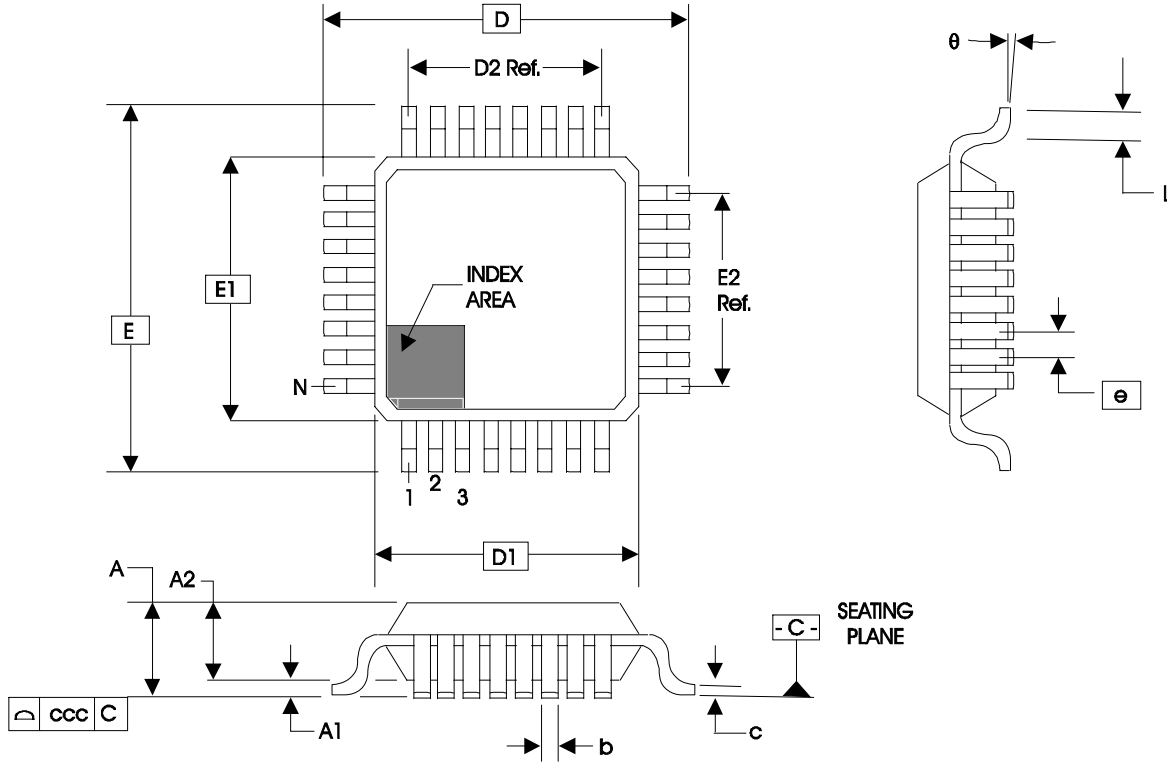

TABLE 8. PACKAGE DIMENSIONS

JEDEC VARIATION ALL DIMENSIONS IN MILLIMETERS			
SYMBOL	BBC		
	MINIMUM	NOMINAL	MAXIMUM
N	48		
A	--	--	1.60
A1	0.05	--	0.15
A2	1.35	1.40	1.45
b	0.17	0.22	0.27
c	0.09	--	0.20
D	9.00 BASIC		
D1	7.00 BASIC		
D2	5.50 Ref.		
E	9.00 BASIC		
E1	7.00 BASIC		
E2	5.50 Ref.		
e	0.50 BASIC		
L	0.45	0.60	0.75
θ	0°	--	7°
ccc	--	--	0.08

Reference Document: JEDEC Publication 95, MS-026



Integrated
Circuit
Systems, Inc.

ICS8702

Low SKEW, $\div 1$, $\div 2$
DIFFERENTIAL-TO-LVCMOS/LVTTL CLOCK GENERATOR

TABLE 9. ORDERING INFORMATION

Part/Order Number	Marking	Package	Shipping Packaging	Temperature
8702BY	ICS8702BY	48 Lead LQFP	tray	0°C to 70°C
8702BYT	ICS8702BY	48 Lead LQFP	1000 tape & reel	0°C to 70°C
8702BYLF	ICS8702BYLF	48 Lead "Lead-Free" LQFP	tray	0°C to 70°C
8702BYLFT	ICS8702BYLF	48 Lead "Lead-Free" LQFP	1000 tape & reel	0°C to 70°C

NOTE: Parts that are ordered with an "LF" suffix to the part number are the Pb-Free configuration and are RoHS compliant.

The aforementioned trademark, HiPerClockS is a trademark of Integrated Circuit Systems, Inc. or its subsidiaries in the United States and/or other countries.

While the information presented herein has been checked for both accuracy and reliability, Integrated Circuit Systems, Incorporated (ICS) assumes no responsibility for either its use or for infringement of any patents or other rights of third parties, which would result from its use. No other circuits, patents, or licenses are implied. This product is intended for use in normal commercial applications. Any other applications such as those requiring extended temperature range, high reliability, or other extraordinary environmental requirements are not recommended without additional processing by ICS. ICS reserves the right to change any circuitry or specifications without notice. ICS does not authorize or warrant any ICS product for use in life support devices or critical medical instruments.



REVISION HISTORY SHEET				
Rev	Table	Page	Description of Change	Date
B	4A	4	Revised IDD row from 70mA Maximum to 95mA Maximum.	8/2/01
	4D	6	Revised IDD row from 70mA Maximum to 95mA Maximum.	
C	4B	4	Revised V _{IH} row from 3.8 Maximum to V _{DD} + 0.3 Maximum.	11/28/01
	4E	6	Revised V _{IH} row from 3.8 Maximum to V _{DD} + 0.3 Maximum.	
		11	Added Power Dissipation and Driver Termination notes.	
C	1	2	Pin Description Table revised nMR/OE description.	8/21/02
		10	Updated Output Rise/Fall Time Diagram. Format changes.	
D	T2	1	Features Section added Lead-Free bullet.	1/17/06
		2	Pin Characteristics Table - changed C _{IN} 4pF max to 4pF typical.	
		9	Added <i>Recommendations for Unused Input and Output Pins</i> .	
		12	Ordering Information Table - added lead-free part number, marking, and note. Updated datasheet layout.	